

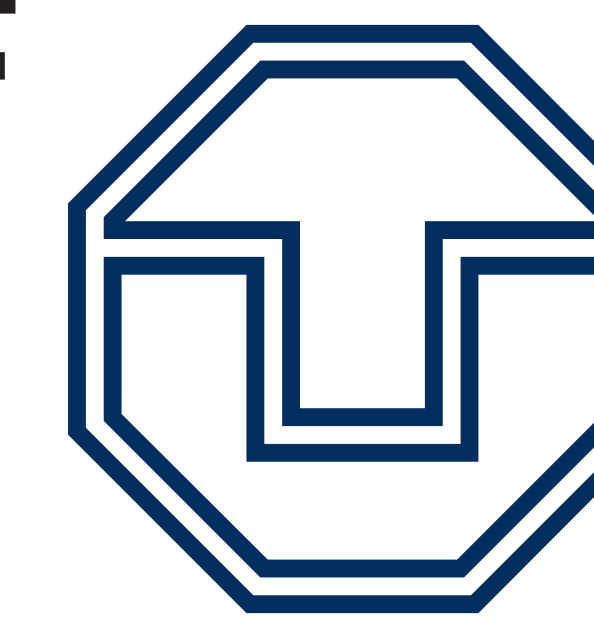

ROYAL INSTITUTE OF TECHNOLOGY

# ON THE IMPACT OF SPATIAL CORRELATION AND PRECODER DESIGN ON THE PERFORMANCE OF MIMO SYSTEMS WITH SPACE-TIME CODING



TECHNISCHE UNIVERSITÄT DRESDEN

Emil Björnson, Björn Ottersten  
ACCESS Linnaeus Center  
Royal Institute of Technology (KTH)  
Stockholm, Sweden

Eduard Jorswieck  
Communications Theory  
Dresden University of Technology  
Dresden, Germany

How does spatial correlation impact the performance?  
With and without statistical CSI at transmitter.

## Introduction

We consider a single-user communication system:

- Multiple antennas:  $n_T$  at transmitter,  $n_R$  at receiver.
- Perfect channel state information (CSI) at receiver.
- No instantaneous CSI at transmitter.

Statistical channel properties important for performance:

- Some spatial directions might on average be more favorable.
- Transmission should be designed based on the statistics.

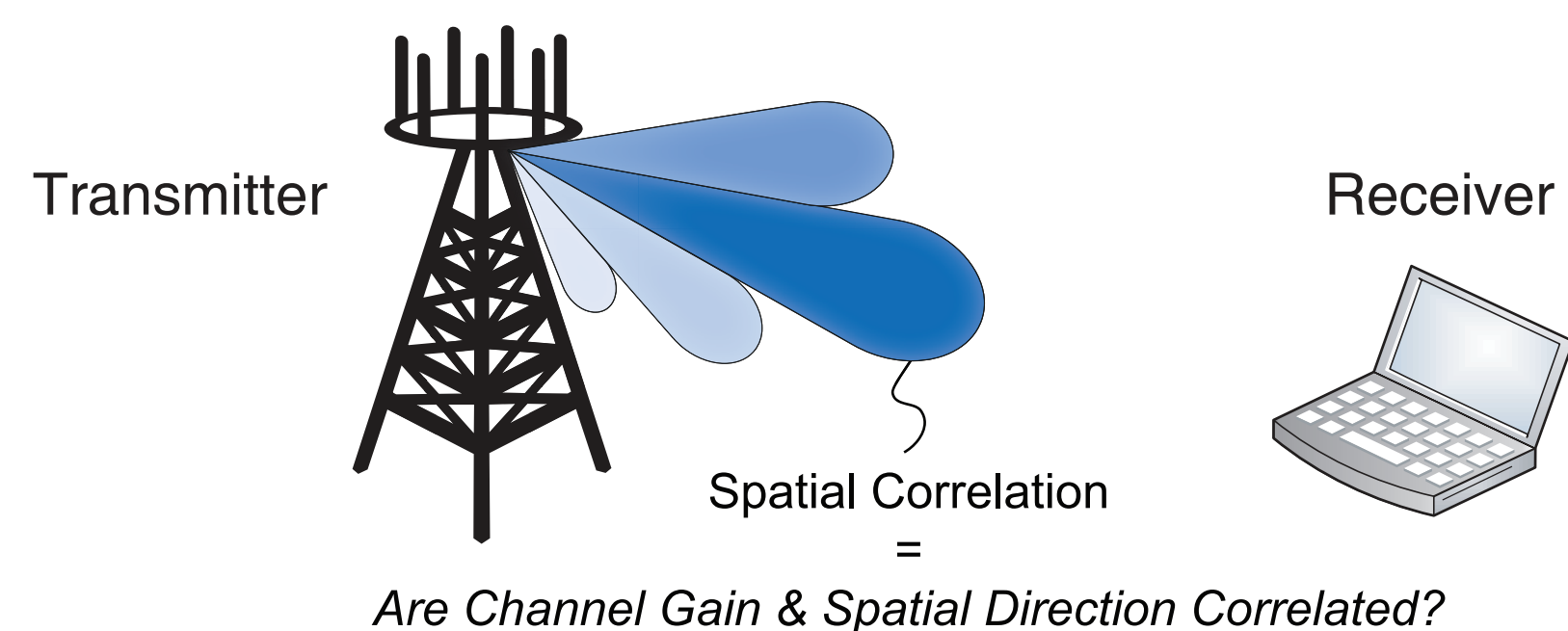

How will spatial correlation affect the system performance?

## Performance Measure: SER

Symbol Error Rate (SER) is the performance measure:

- Probability that receiver makes an error in symbol detection.
- Depends on type of symbol constellation, SNR, and statistics.

Definition. Let  $\Phi = \mathbf{R}_R \otimes (\mathbf{W}\mathbf{W}^H \mathbf{R}_T)$  and define

$$F_{a,b}(g) = \frac{1}{\pi} \int_a^b \frac{d\theta}{\det(\mathbf{I} + \frac{\gamma g}{\sin^2(\theta)} \Phi)}, \quad g \geq 0, b \geq a.$$

SER for  $M$ -PAM,  $M$ -PSK, and  $M$ -QAM symbol constellations:

$$\begin{aligned} \text{SER}_{\text{PAM}} &= \frac{2(M-1)}{M} F_{0, \frac{\pi}{2}}(g_{\text{PAM}}), \\ \text{SER}_{\text{PSK}} &= F_{0, \frac{M-1}{M}\pi}(g_{\text{PSK}}), \\ \text{SER}_{\text{QAM}} &= \frac{4(\sqrt{M}-1)}{M} (F_{0, \frac{\pi}{4}}(g_{\text{QAM}}) + \sqrt{M} F_{\frac{\pi}{4}, \frac{\pi}{2}}(g_{\text{QAM}})), \end{aligned}$$

with  $g_{\text{PAM}} = \frac{3}{M^2-1}$ ,  $g_{\text{PSK}} = \sin^2(\frac{\pi}{M})$ , and  $g_{\text{QAM}} = \frac{3}{2(M-1)}$ .

## Measure of Spatial Correlation

How to analyze the impact of spatial correlation?

- The determinant in  $F_{a,b}(g)$  depends on the eigenvalues of  $\Phi$ :  
$$\det(\mathbf{I} + \frac{\gamma g}{\sin^2(\theta)} \Phi) = \prod_{k=1}^{n_T n_R} (1 + \frac{\gamma g}{\sin^2(\theta)} \lambda_k(\Phi)),$$
- Different spatial correlations = Different eigenvalue distributions.

Majorization: If two vectors  $\mathbf{x}$  and  $\mathbf{y}$ , with ordered elements  $x_1 \geq x_2 \geq \dots \geq x_M$  and  $y_1 \geq y_2 \geq \dots \geq y_M$ , satisfy

$$\sum_{k=1}^m x_k \geq \sum_{k=1}^m y_k, \quad \text{for } m=1, \dots, M-1, \quad \text{and} \quad \sum_{k=1}^M x_k = \sum_{k=1}^M y_k,$$

then  $\mathbf{x}$  majorizes  $\mathbf{y}$ . Notation:  $\mathbf{x} \succeq \mathbf{y}$ .

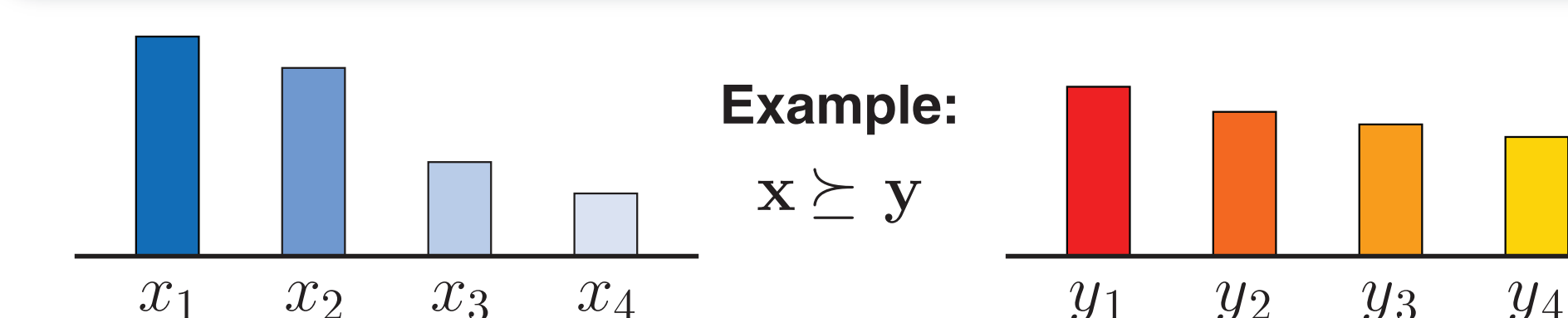

Interpretation for eigenvalues of correlation matrices:

- $\mathbf{x}$  and  $\mathbf{y}$  contain eigenvalues of correlation matrices  $\mathbf{R}_1$  and  $\mathbf{R}_2$ .
- $\mathbf{x} \succeq \mathbf{y}$  means  $\mathbf{R}_1$  is more spatially correlated than  $\mathbf{R}_2$ .

Schur-convex and Schur-concave: A function  $f(\cdot): \mathbb{R}^M \rightarrow \mathbb{R}$  is

- Schur-convex if  $\mathbf{x} \succeq \mathbf{y}$  implies  $f(\mathbf{x}) \geq f(\mathbf{y})$ .
- Schur-concave if  $\mathbf{x} \succeq \mathbf{y}$  implies  $f(\mathbf{x}) \leq f(\mathbf{y})$ .

## Dependence on Spatial Correlation

Without CSI at transmitter:

- Theorem 1. The function  $F_{a,b}(g)$  is Schur-convex with respect to
- Eigenvalues of  $\mathbf{R}_T$  for fixed  $\mathbf{R}_R$ .
  - Eigenvalues of  $\mathbf{R}_R$  for fixed  $\mathbf{R}_T$ .

With statistical CSI at transmitter:

- Theorem 2. The function  $F_{a,b}(g)$  with optimal precoding is
- Schur-concave w.r.t. eigenval. of  $\mathbf{R}_T$  for fixed  $\mathbf{R}_R$  at low SNR.
  - Schur-convex w.r.t. eigenval. of  $\mathbf{R}_T$  for fixed  $\mathbf{R}_R$  at high SNR.
  - Schur-convex w.r.t. eigenval. of  $\mathbf{R}_R$  for fixed  $\mathbf{R}_T$  at all SNRs.

## Numerical Examples

When is spatial correlation useful in practice?

- Transmit side correlation shown to be desirable at low SNR.
- How to interpret this in practice?
- At least  $\gamma \leq \frac{1}{g_{\text{tr}}(\mathbf{R}_T) \text{tr}(\mathbf{R}_R)}$  corresponds to low SNR.
- From simulation: Approximate low SNR behavior at all SNRs.

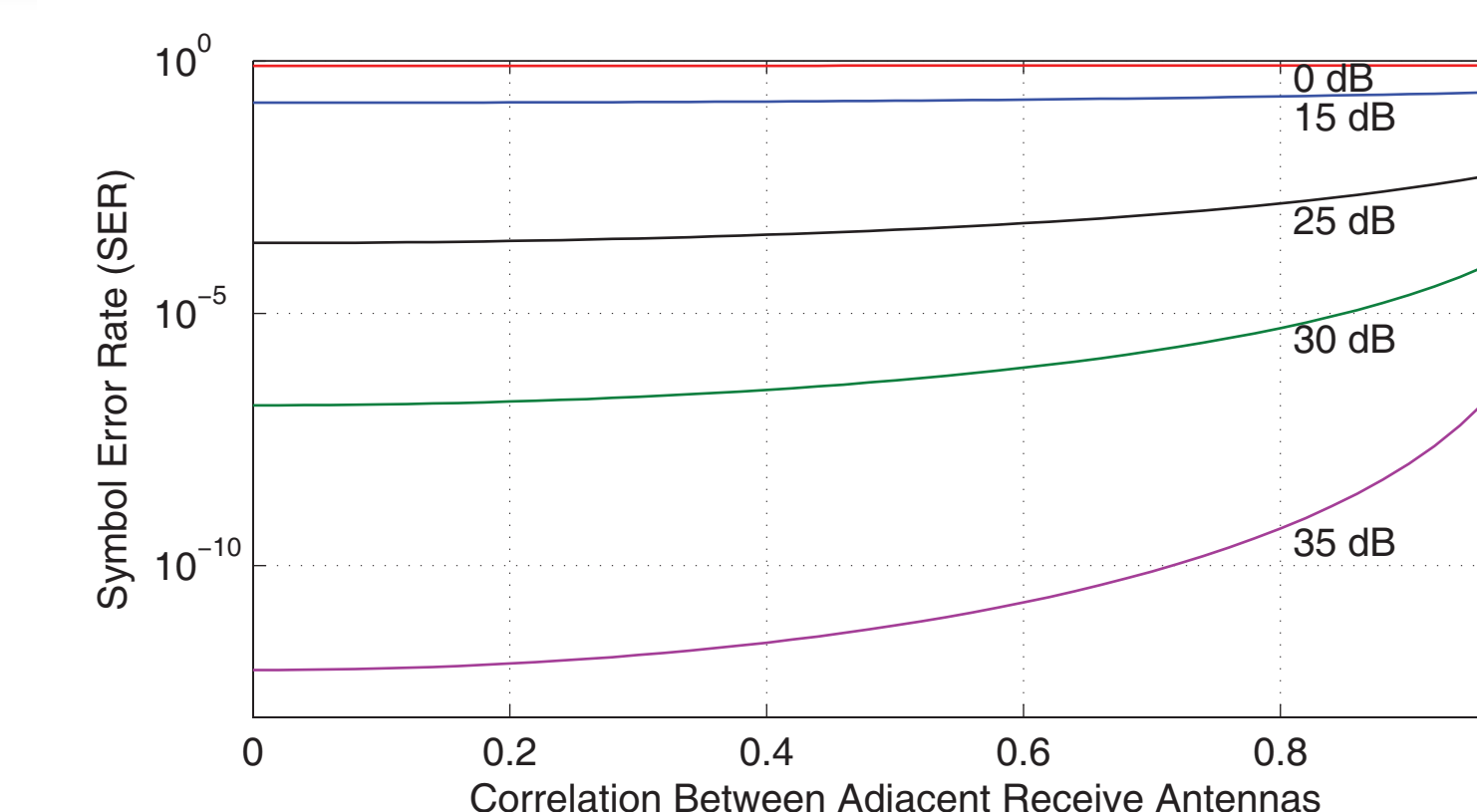

The SER as function of correlation between adjacent receive antennas in a four-antenna array. The transmitter has  $n_T = 4$  and a fixed correlation of 0.5. The SER is Schur-convex at all SNRs.

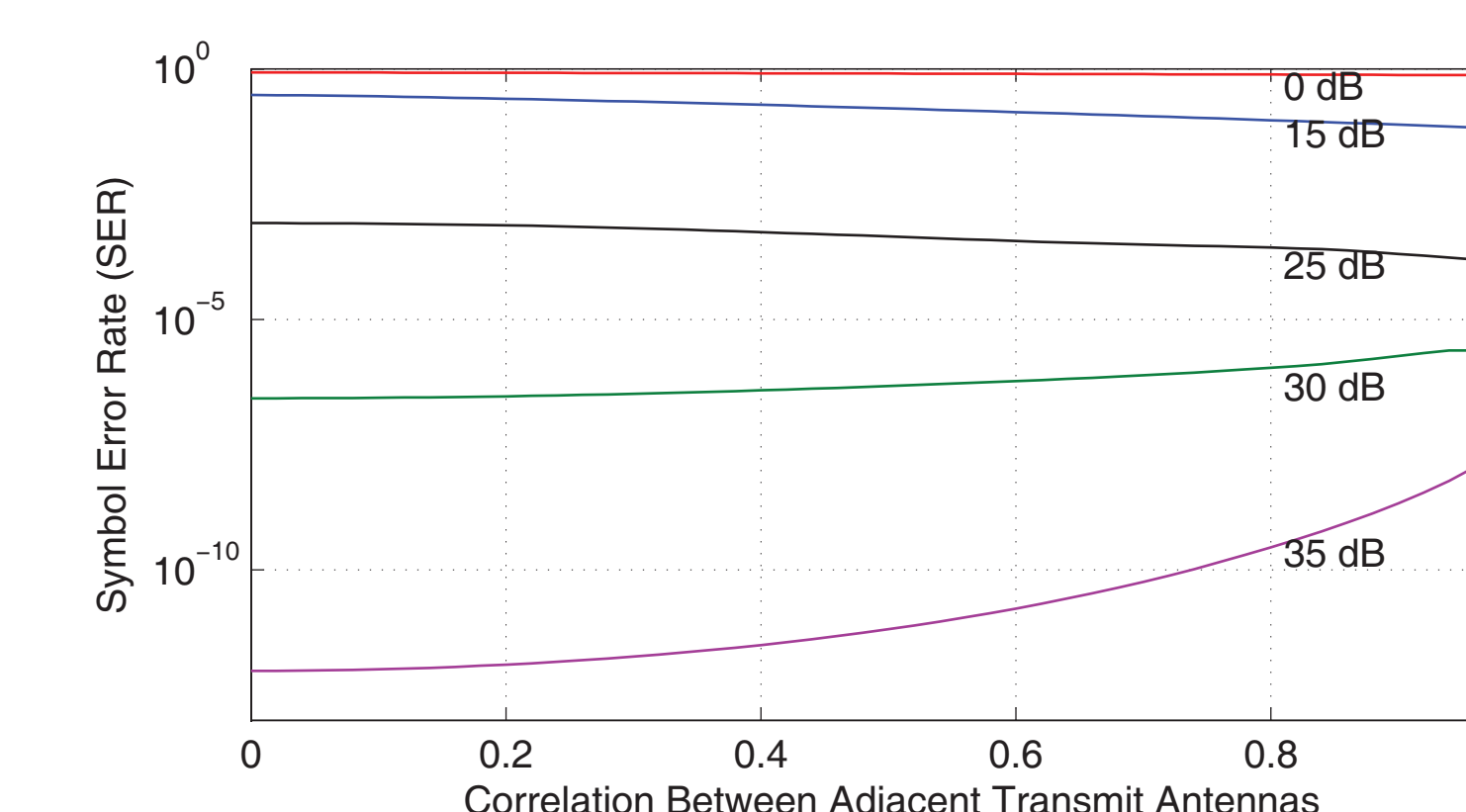

The SER as function of correlation between adjacent transmit antennas in a four-antenna array. The receiver has  $n_R = 4$  and a fixed correlation of 0.5. The SER is Schur-concave at low and medium SNR and becomes Schur-convex at high SNR.

## System model

Rayleigh fading channel with Kronecker structure:

$$\mathbf{H} = \mathbf{R}_R^{1/2} \tilde{\mathbf{H}} \mathbf{R}_T^{1/2}$$

- $\mathbf{R}_T$  transmit correlation matrix,  $\mathbf{R}_R$  receive correlation matrix.
- $\tilde{\mathbf{H}}$  i.i.d. zero-mean complex Gaussian matrix with unit variance.

Transmission with orthogonal space-time block codes (OSTBCs):

$$\mathbf{Y} = \mathbf{H}\mathbf{W}\mathbf{C}(\mathbf{s}) + \mathbf{N},$$

- $K$  symbols over  $T$  slots:  $\mathbf{s} = [s_1, \dots, s_K]^T$  (coding rate:  $\frac{K}{T}$ ).
- Average symbol power  $E\{|s_k|^2\} = \gamma$ , spatial dimension  $B$ .
- Linear precoder,  $\mathbf{W} \in \mathbb{C}^{n_T \times B}$ , power constraint  $\|\mathbf{W}\|^2 = 1$ .

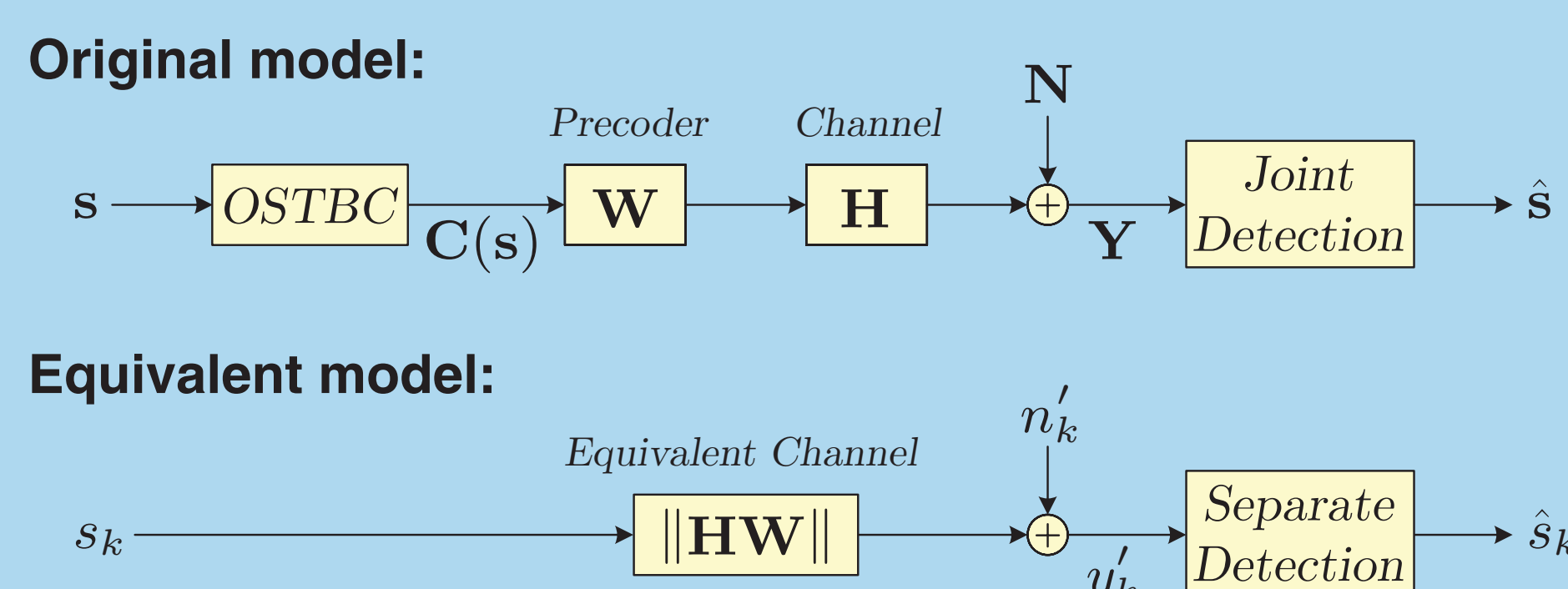

## Precoding Design

Goal: Minimize SER by design of linear precoder  $\mathbf{W}$ .

- Without CSI at transmitter: Minimize worst-case SER by  $B = n_T$  and  $\mathbf{W} = \frac{1}{\sqrt{n_T}} \mathbf{I}$ .
- With statistical CSI at transmitter: Adapt  $\mathbf{W}$  and  $B \leq n_T$  to the spatial properties.

Optimal precoder structure:  $\mathbf{W} = \mathbf{U}_T \Delta$ .

- $\Delta \Delta^T = \text{diag}(\sqrt{p_1}, \dots, \sqrt{p_B}, 0, \dots, 0)$ ,  $\sum_{k=1}^B p_k = 1$ .
- $\mathbf{U}_T$  contain eigenvectors of  $\mathbf{R}_T$ , decreasing in dominance.

Example of precoder power allocation:

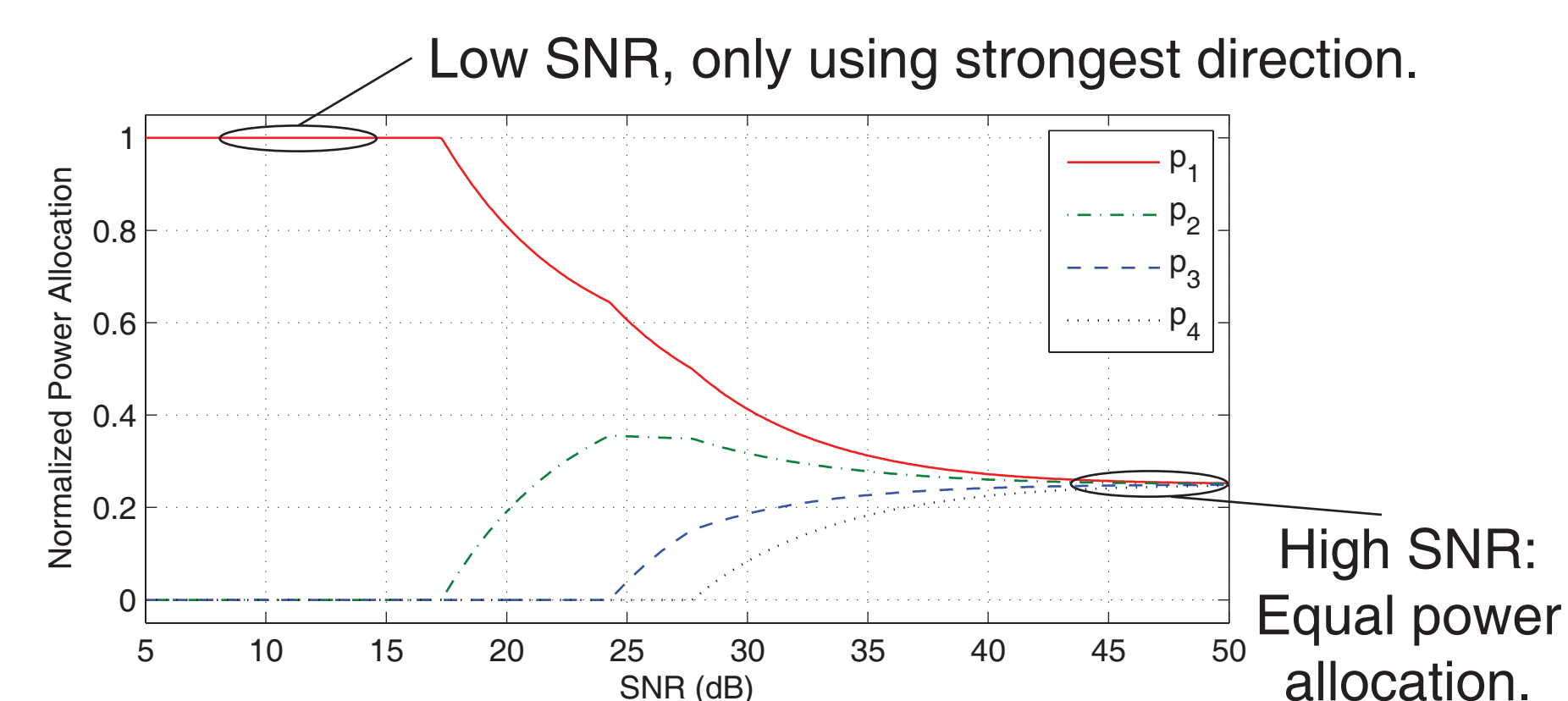

## Conclusions & Contributions

Analysis of impact of spatial correlation with different CSI on

- Symbol Error Rate of  $M$ -PAM,  $M$ -PSK, and  $M$ -QAM.

Without CSI at transmitter:

- Spatial correlation always degrades performance.

With statistical CSI at transmitter and optimal precoding:

- Spatial correlation at transmitter improves performance.
- Spatial correlation at receiver still degrades performance.